



Abelas
Alexan SL

f.rager.
magnetude® façade®
PATENTED TECHNOLOGY

accesorios

2024

intro

accesorios

Frager es desde hace mucho tiempo el pionero absoluto en materia de paneles de puerta.

Las tendencias actuales en arquitectura e interiorismo nos animan desde hace más de 40 años a ofrecer cada vez un poco más a nuestros clientes.....

Con este folleto "accesorios", continuamos innovando nuestra gama de tiradores para puertas.

Más que nunca, la gente elige conscientemente el tirador de la puerta, que constituye el elemento de cierre definitivo y da a su puerta toda su potencia

A veces muy discretamente integrado, a veces un verdadero atractivo arquitectónico, pero siempre respetando la arquitectura específica de la casa.

Estamos especialmente orgullosos de los nuevos productos presentados en este folleto.

En esta renovada gama, sin duda encontrará el acabado óptimo para cada puerta.

AVANCE DE LAS PRINCIPALES NOVEDADES

- Gama completa de tiradores de puerta de acero inoxidable ahora también disponibles en colores termo lacados (RAL): además del negro estándar, todos los artículos en acero inoxidable ahora también están disponibles en todos los colores termo lacados posibles.
- **FORMAS:** tiradores de puertas hechos a mano con iluminación LED elegantemente integrada
- **PLANCHAS:** patrones geométricos desiguales y audaces
- Mejoras en la gama clásica de estilo rústico

No dude en ponerse en contacto con nosotros si desea más información.

TIRADORES

DB2022	37
DB2023	37
DB2024	37
DB2025	37
DB2120 *	21
DB2123 *	21
DB2124 *	21
DB2125 *	22
DB2126 *	22
DB2127 *	22
DB2128 *	22
DB2131 *	23
DB2132 *	23
DB2133 *	23
DB2134 *	24
DB2135 *	24
DB2136 *	24
DB2140 *	24
DB2141 *	24
DB2142 *	24
DB2143 *	29
DB2152 *	25
DB2153 *	25
DB2154 *	25
DB2211	16
DB2212	16
DB2221	31
DB2222	31
DB2224 *	26
DB2225 *	26
DB2226 *	26
DB2227 *	26
DB2250 *	26
DB2251 *	26

DB2252 *	26
DB2253 *	26
DB2254 *	26
DB2255 *	26
DB2256 *	27
DB2257 *	27
DB2259 *	27
DB2260 *	27
DB2261 *	27
DB2262 *	27
DB2263 *	26
DB2264 *	26
DB2265 *	27
DB2266 *	27
DB2290 *	30
DB2291 *	30
DB2292	28
DB2293	28
DB2294	29
DB2295	29
DB2370	7
DB2371	8
DB2717	34
DB2721	31
DB2722	31
DB2790 *	30
DB2791 *	30
DB2811	32
DB2813	32
DB2816	32
DB2817	32
DB2818	32
DB2821	32
DB2860	32
DB2861	32

DB2911	33
DB2913	33
DB2914	33
DB2916	34
DB2917	34
DB2918	36
DB2921	36
DB2950/DB2850	35
DB2951/DB2851	35
DB2952/DB2852	35
DB2960	36
DB2961	36

FORMAS

DB2001	39
DB2002	39
DB2003	39
DB2004	39
DB2005	39
DB2006	39
DB2007	39
DB2008	39

PLANCHAS

DB2009	40
DB2010	40
DB2011	41
DB2012	41
DB2013	40
DB2014	40
DB2015	41
DB2016	41

MANILLAS

DB1215	29
DB1216	29
DB1359	15
DB1360	15
DB1363	16

BOCALLAVE

DB3201	29
DB3202	29
DB3342	9
DB3356	15
DB3362	16

BUZON

DB4355	18
DB4357	18

MIRILLA

DB6029	29
--------	----

INSTRUCCIONES

DE MONTAJE	42
------------	----

MANTENIMIENTO	44
---------------	----

VT Estaño envejecido

VZ Negro envejecido

RK Cobre rojo

VB Bronce envejecido

SN Estaño

ZW Negro - Axalta SD30C - 49005 - 20

IN Inox

PL Lacado RAL

 Tirador con una textura artesanal única
posibilidad de hacer a medida

 Posibilidad de personalización

* Adecuado para montaje ciego o par parejas



A partir de ahora, los tiradores en Inox también estarán disponibles en acabado termo lacado (mate/brillo/texturado)





DB2370VT

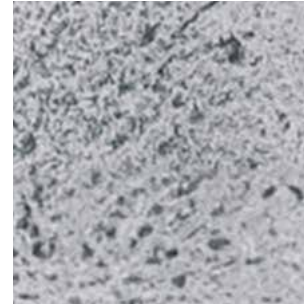

VT

ESTAÑO
ENVEJECIDO



VZ

NEGRO
ENVEJECIDO



RK

COBRE
ROJO



DB2371VZ



DB2371RK



DB2370RK



DB2370VT



DB2370VZ



DB2370RK

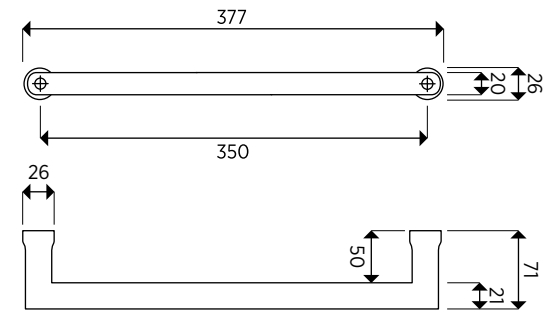



DB2371VT



DB2371VZ



DB2371RK

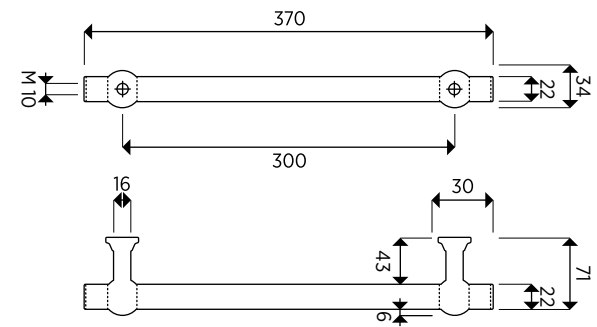



DB3342RK



DB3342VT



DB3342VZ



DB3342RK

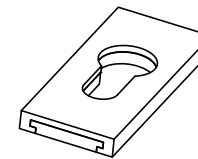
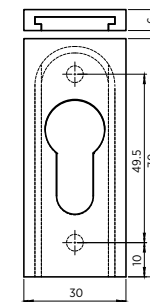



DB2350SN

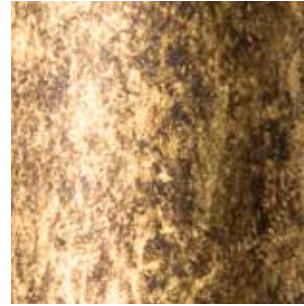

VB

BRONCE
ENVEJECIDO



SN

ESTAÑO

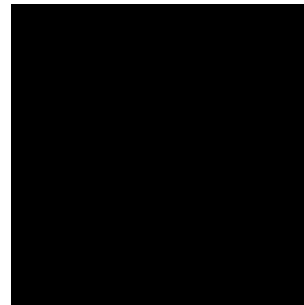

ZW

NEGRO



DB2350VB



DB2350SN



DB2350ZW

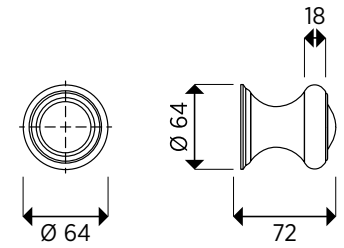

DB2351VB



DB2351SN



DB2351ZW

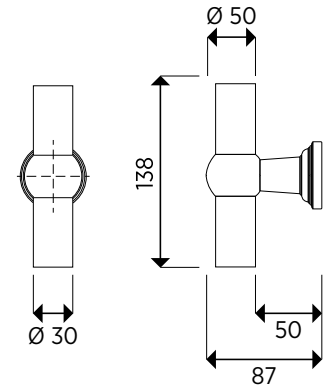

DB2352VB



DB2352SN



DB2352ZW

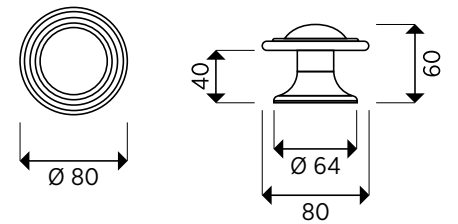



DB2353SN



DB2353VB



DB2353SN



DB2353ZW

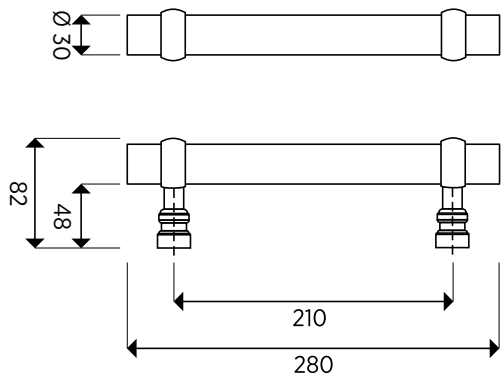



DB2354VB



DB2354SN



DB2354ZW

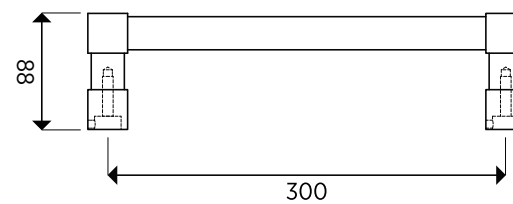



DB2361VB



DB2361SN



DB2361ZW

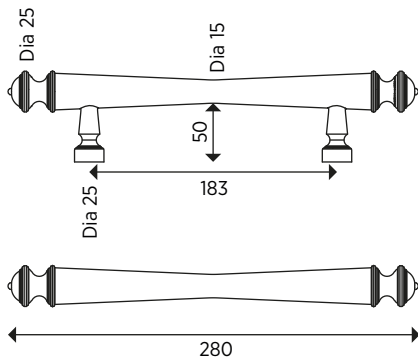



DB1359VB



DB1360VB



DB3356VB



DB1359SN



DB1360SN



DB3356SN



DB1359ZW



DB1360ZW



DB3356ZW

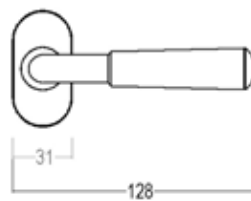
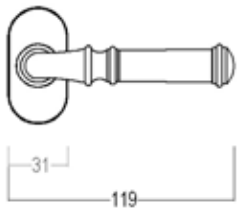

Todas nuestras manillas de puerta se pueden utilizar tanto a la izquierda como a la derecha.

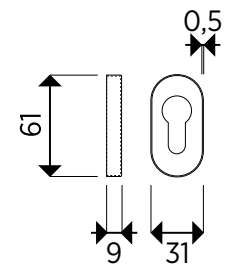



DB1363VB



DB3362VB

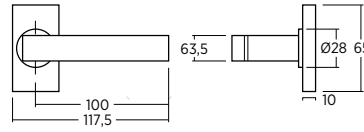

DB1363SN



DB3362SN

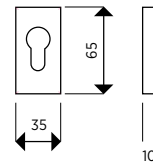

DB1363ZW



DB3362ZW



DB1363PL



DB3362PL



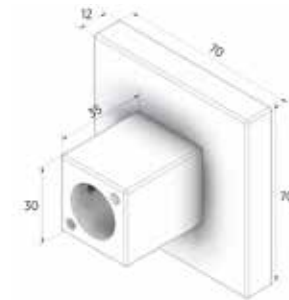
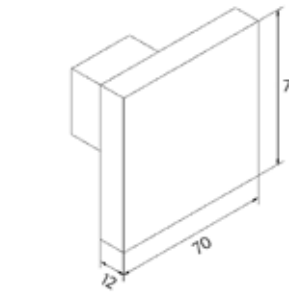

Todas nuestras manillas de puerta se pueden utilizar tanto a la izquierda como a la derecha.

NEW
La Manilla DB1363PL y el Bocallave DB3362PL también estarán disponibles en acabado termo lacado

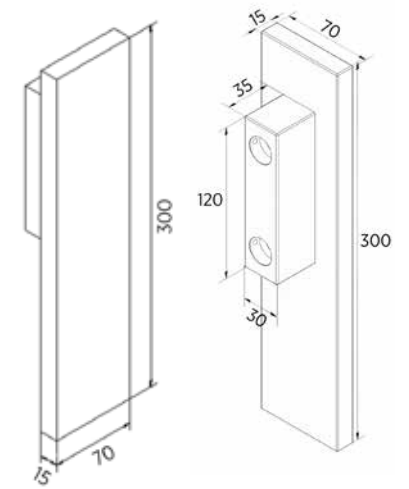

DB2211



DB2212





EXTERIOR

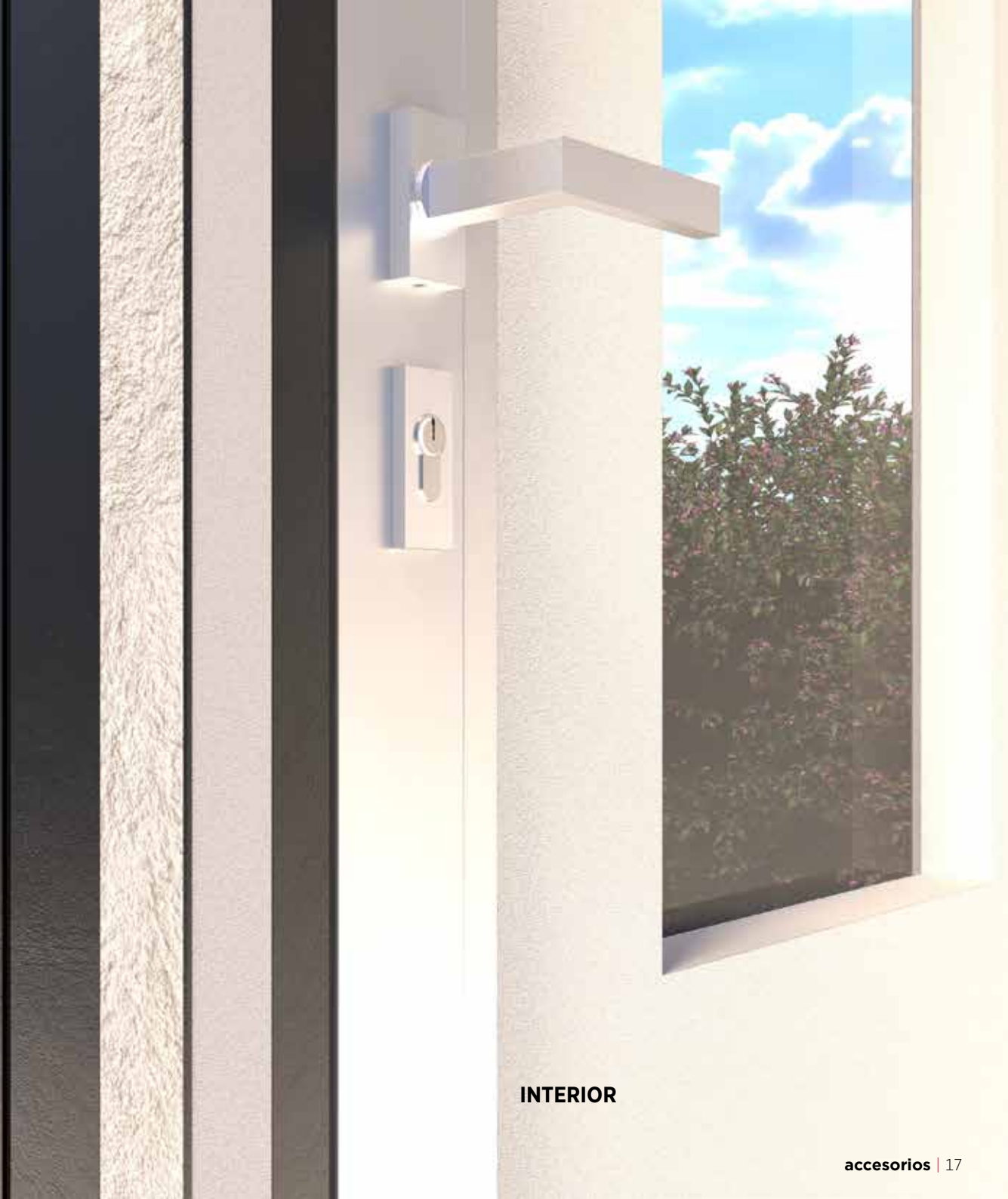

INTERIOR

EXTERIOR



DB4355VB



DB4355SN



DB4355ZW



DB4355IN

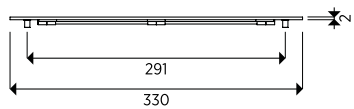
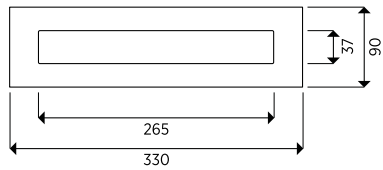

INTERIOR



DB4357

IN ZW

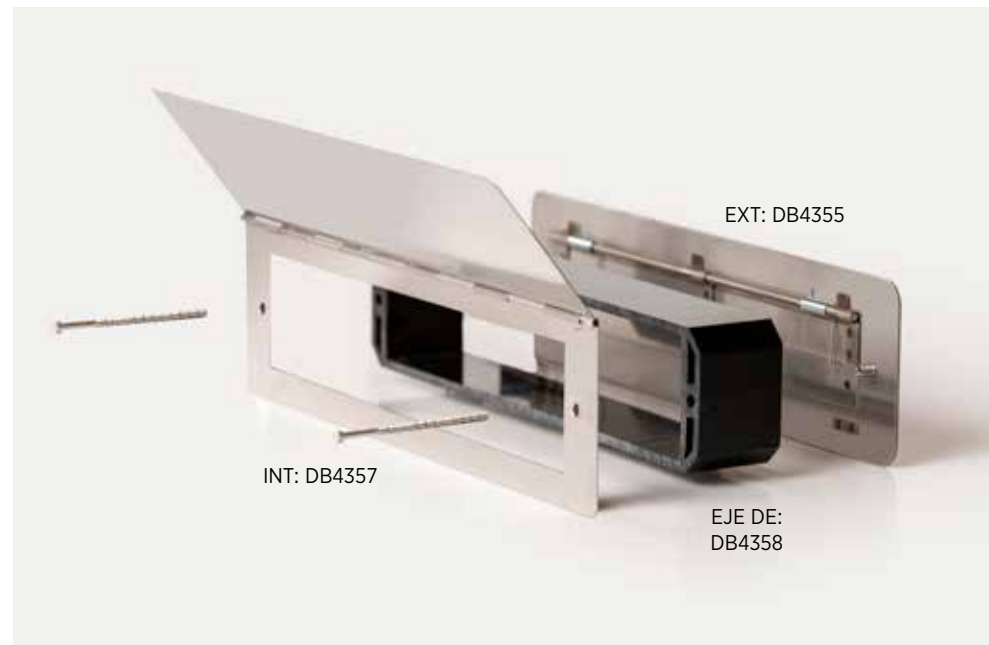
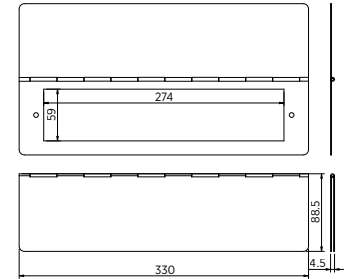



SOLAPADO

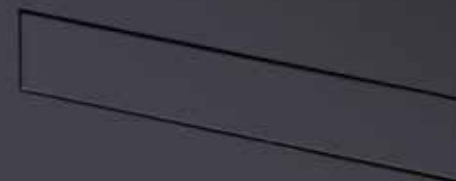

ENRASADO



En caso de montaje enrasado, la solapa exterior será siempre en el mismo color del panel.

La solapa interior no podrá ser nunca enrasada.



SOLAPA INTERIOR



DB22951N

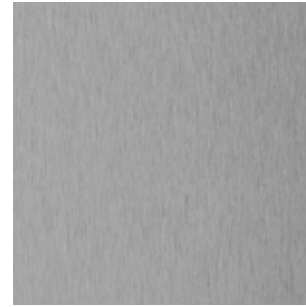

IN

INOX

(AISI 316)



ZW

NEGRO

(AXALTA SD30C - 49005 - 20)



PL

LACADO RAL

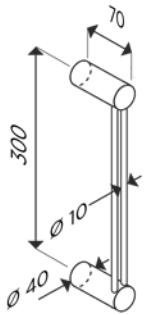

DB2120

IN ZW PL

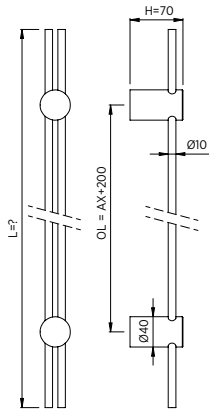

DB2123

AX=300

DB2124

AX=500

IN ZW PL



DB2124IN



DB2128IN

Mainel : Frager Facade

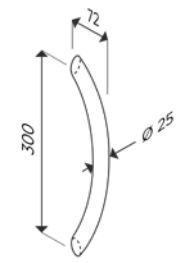

DB2125

IN ZW PL

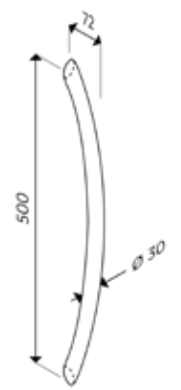

DB2126

IN ZW PL

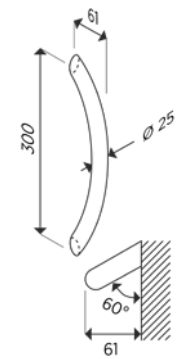
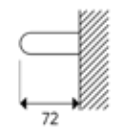
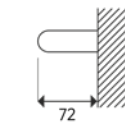

DB2127

IN ZW PL

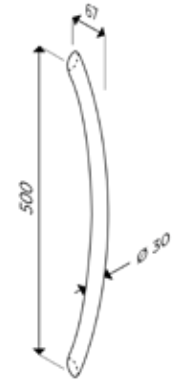

DB2128

IN ZW PL

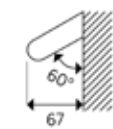



DB2133IN

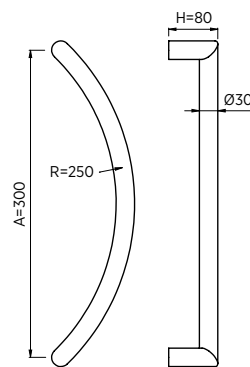

DB2131

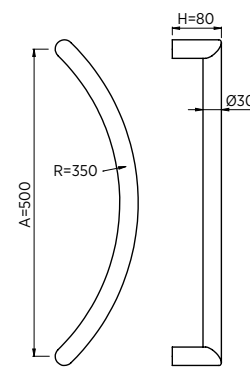

DB2132

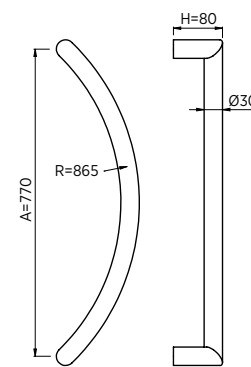

DB2133



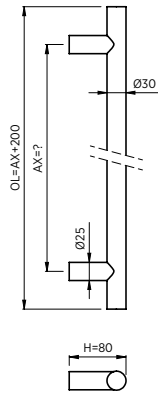
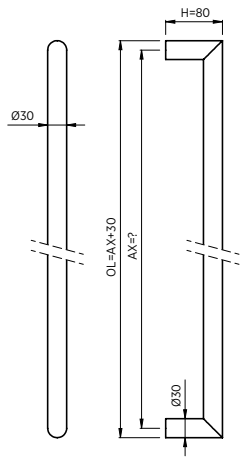

DB2134
AX=300
DB2135
AX=650
DB2136
AX=1000

DB2140
AX=300
DB2141
AX=500
DB2142
AX=1000



DB2140ZW

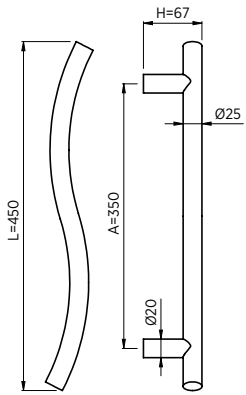

DB2152

IN ZW PL

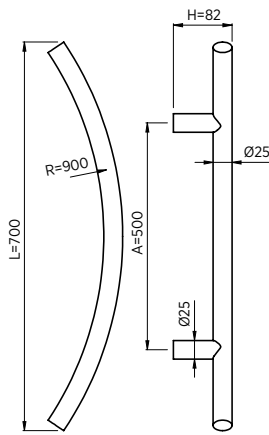

DB2153

IN ZW PL

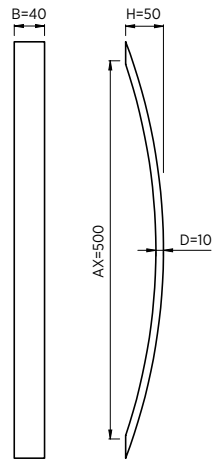

DB2154

IN ZW PL



DB2153IN

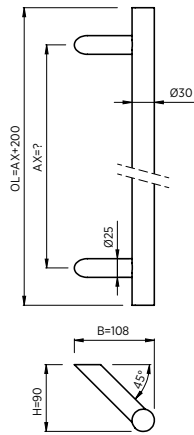

DB2224

AX=300

DB2225

AX=500

DB2226

AX=700

DB2227

AX=1000

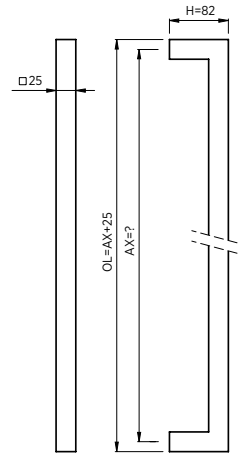

DB2250

AX=300

DB2251

AX=500

DB2263

AX=700

DB2252

AX=1000

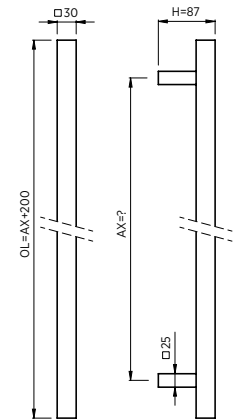

DB2253

AX=300

DB2254

AX=500

DB2264

AX=700

DB2255

AX=1000





DB2260IN

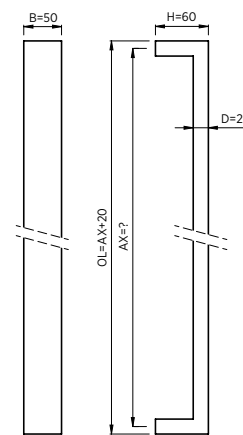

DB2256
 AX=300
DB2262
 AX=500
DB2265
 AX=700
DB2257
 AX=1000

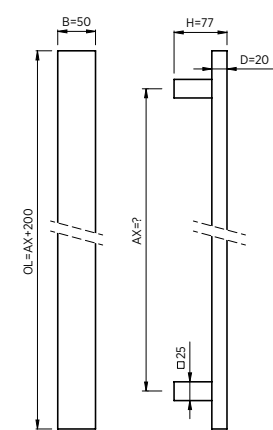

DB2259
 AX=300
DB2260
 AX=500
DB2266
 AX=700
DB2261
 AX=1000



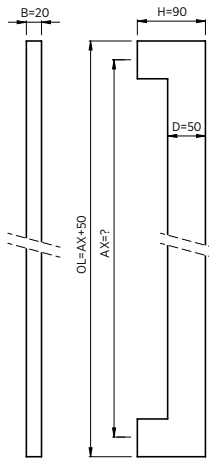

DB2292
AX=500
DB2293
AX=1000



DB2292PL

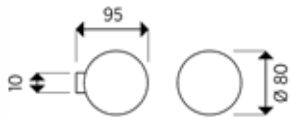

DB2143

IN ZW PL

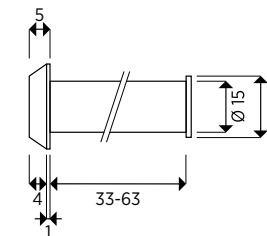
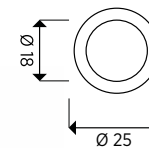

DB6029

IN ZW

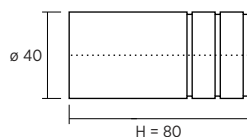

DB2294

IN ZW PL

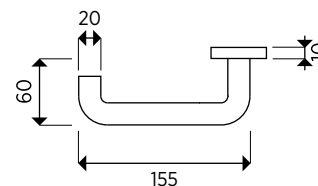

DB1215

IN

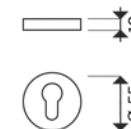

DB3202

IN

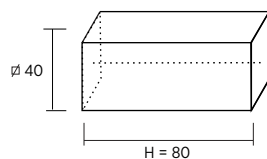

DB2295

IN ZW PL

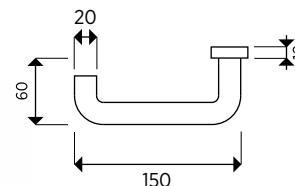

DB1216

IN ZW PL

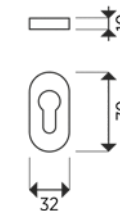

DB3201

IN ZW PL

SÓLO APTO PARA MONTAJE TRADICIONAL

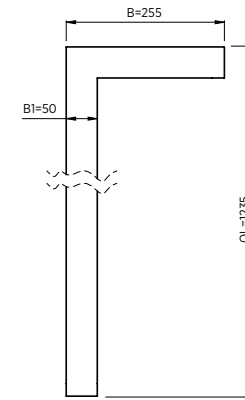

DB2790

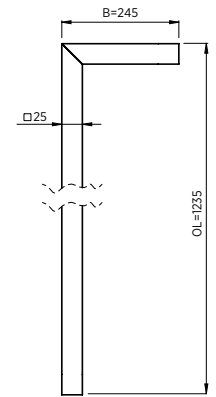

DB2791

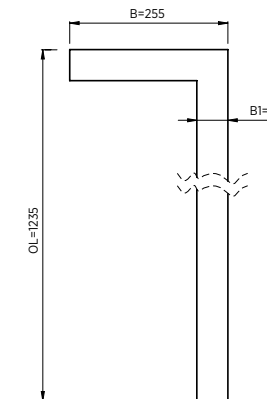

DB2290

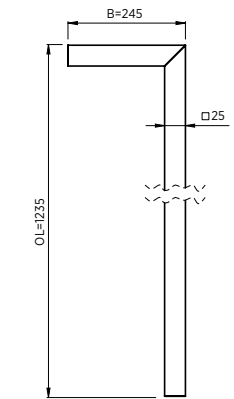

DB2291



DB2791ZW

SÓLO APTO PARA MONTAJE MAGNETUDE®

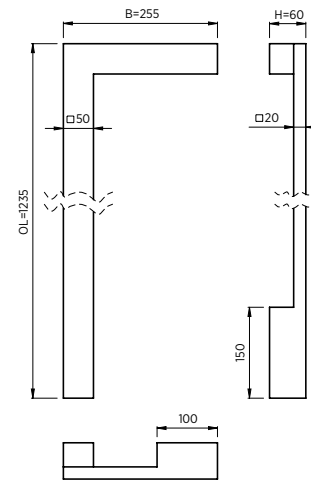

DB2721

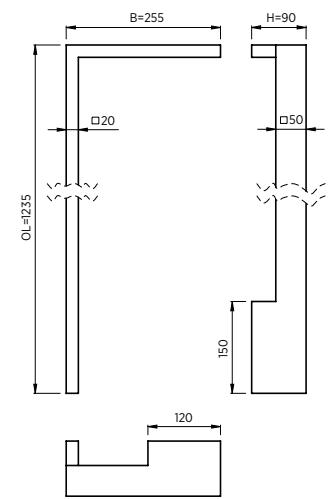

DB2722

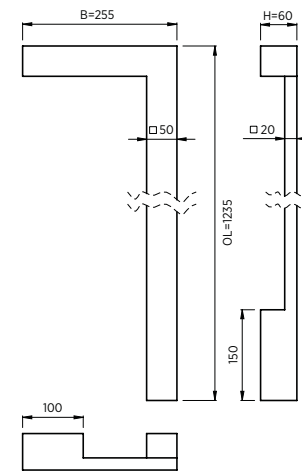

DB2221

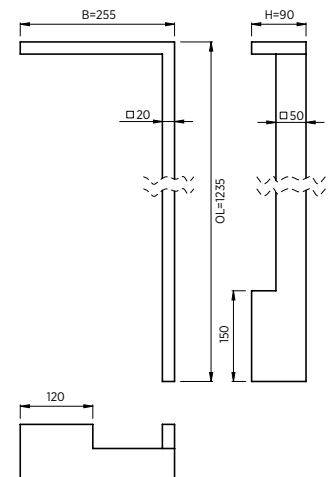

DB2222





PL

LACADO RAL

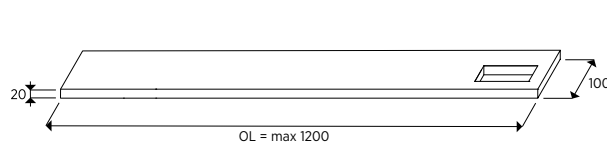

DB2811PL  

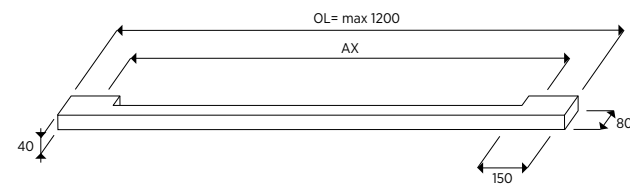

DB2813PL  

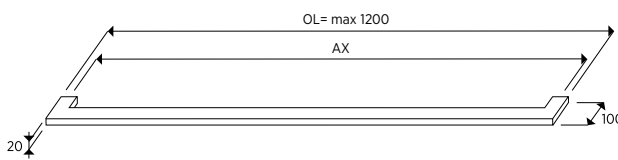

DB2816PL  

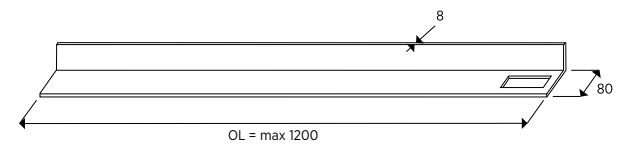

DB2817PL  

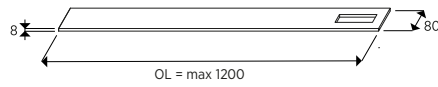

DB2818PL  

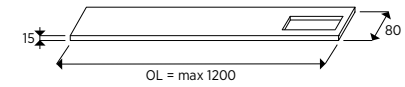

DB2821PL  

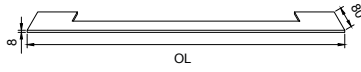

DB2860PL  

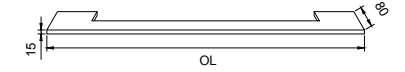

DB2861PL  

DB2818ZW

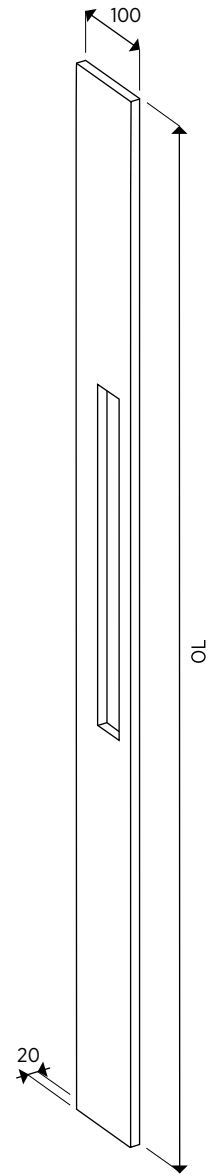

DB2911PL

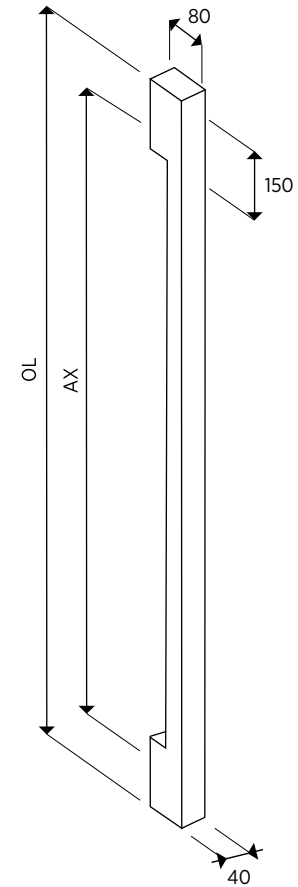

DB2913PL

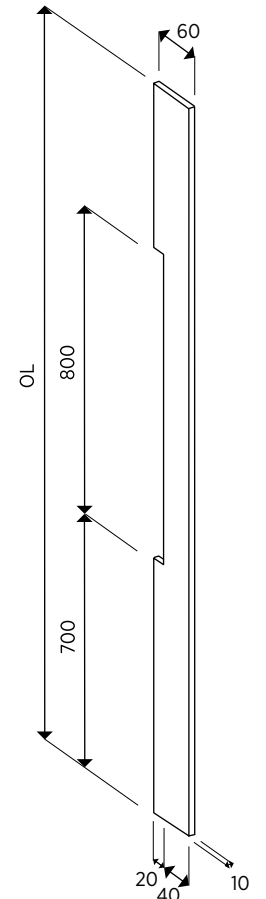

DB2914PL





DB2717PL

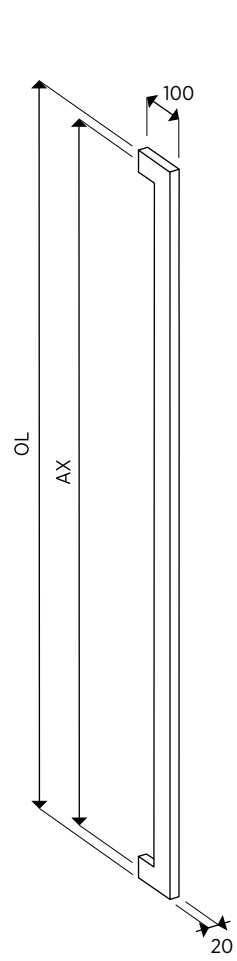

DB2916PL

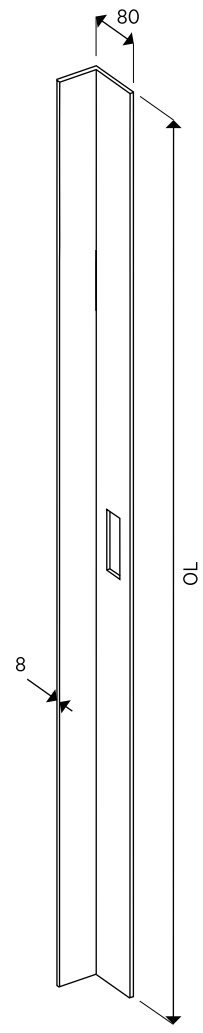
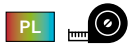

DB2717PL

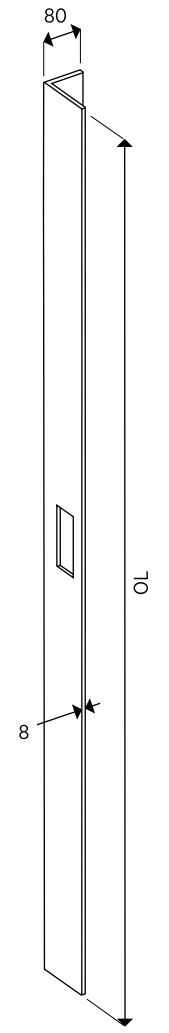
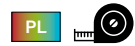

DB2917PL



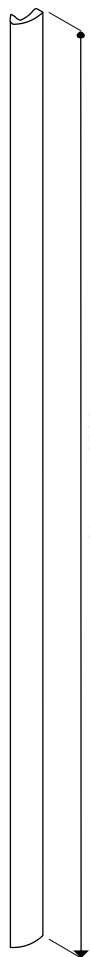

OL = max. 2500

DB2950PL

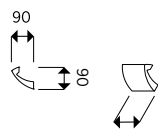

OL = max. 1200

DB2850PL



OL = max. 2500

DB2951PL

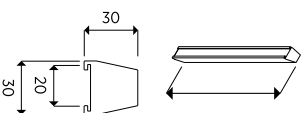

OL = max. 1200

DB2851PL

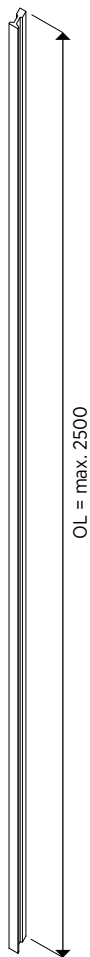

OL = max. 2500

DB2952PL

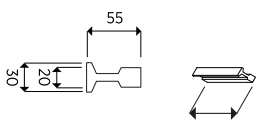

OL = max. 1200

DB2852PL



DB2952PL

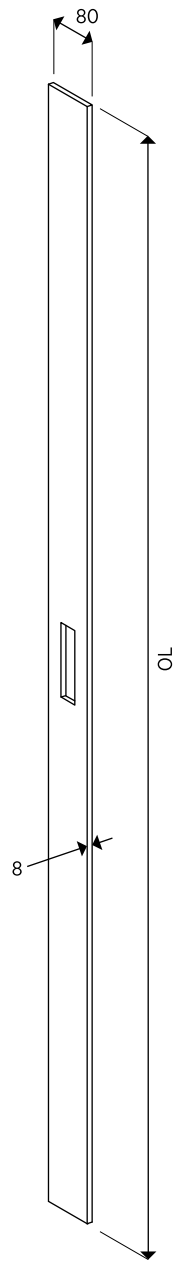

DB2918PL

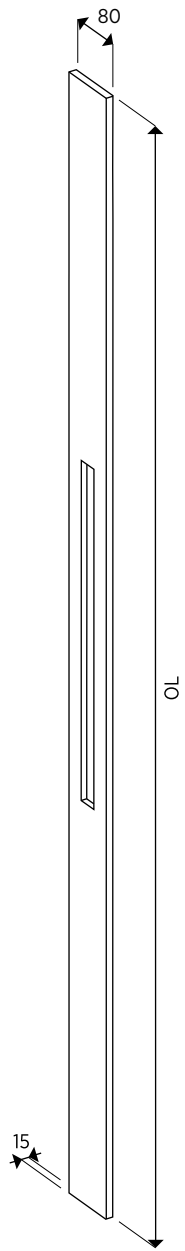

DB2921PL



DB2921PL



DB2960PL



DB2961PL





DB2022PL

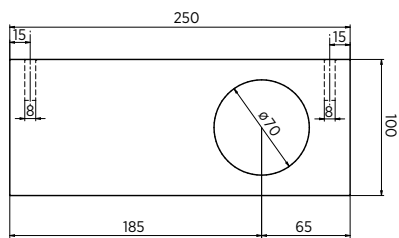

DB2022PL

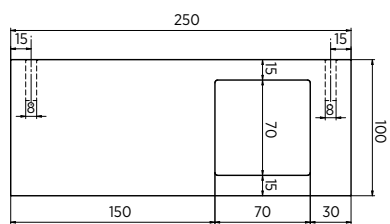

DB2023PL

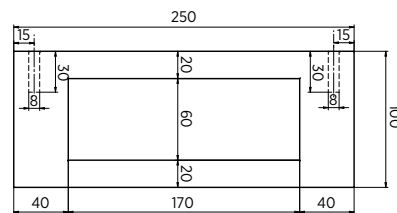

DB2024PL

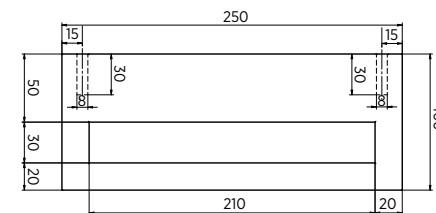

DB2025PL



Formas

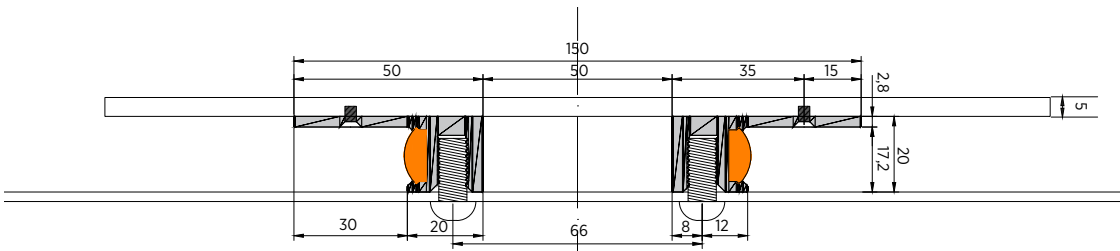
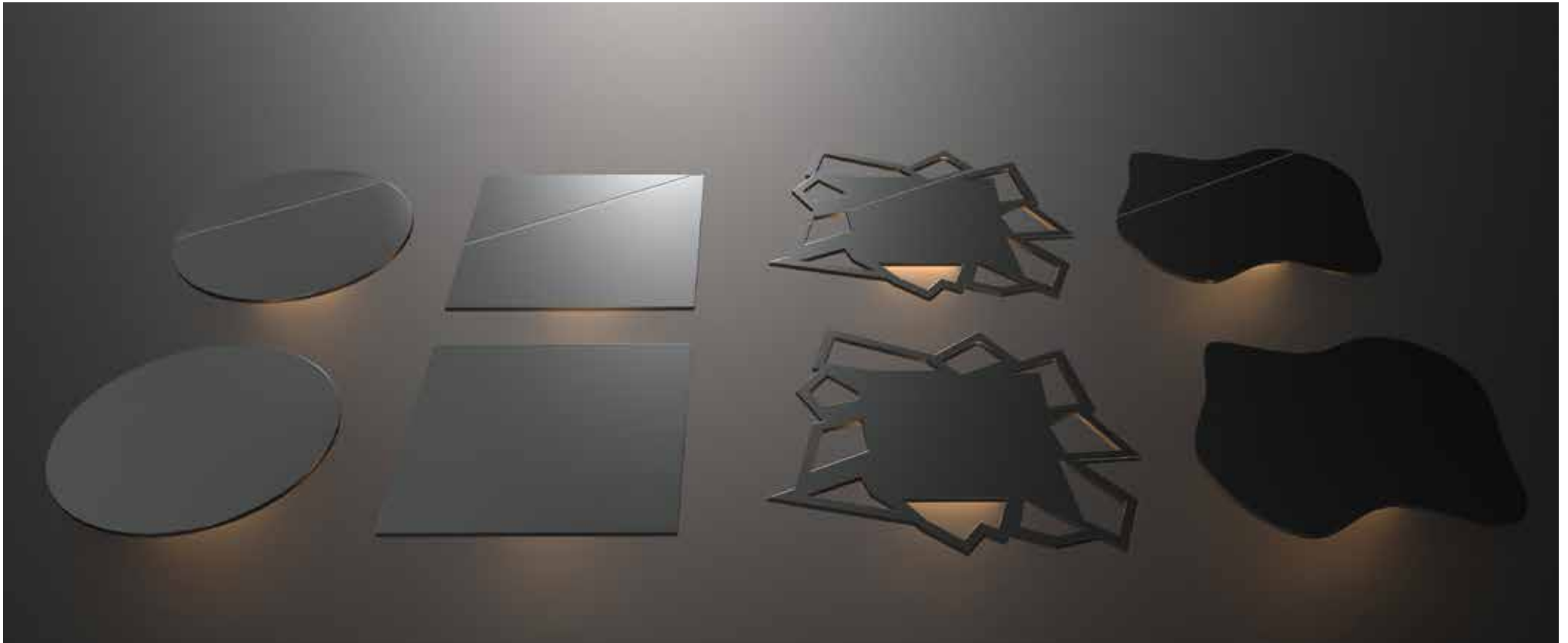



DB2001PL



DB2002PL



DB2003PL



DB2004PL



DB2005PL



DB2006PL



DB2007PL



DB2008PL

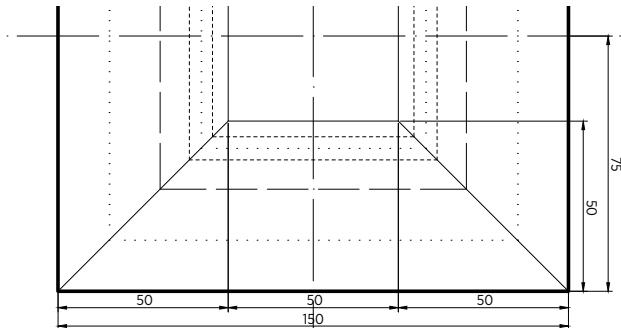

DB2006PL

Planchas

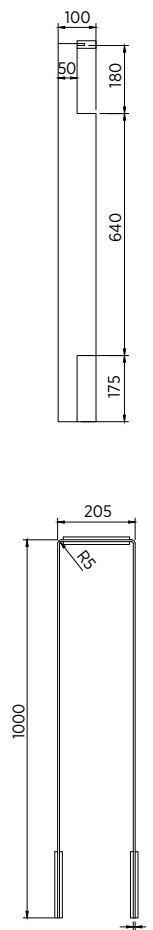
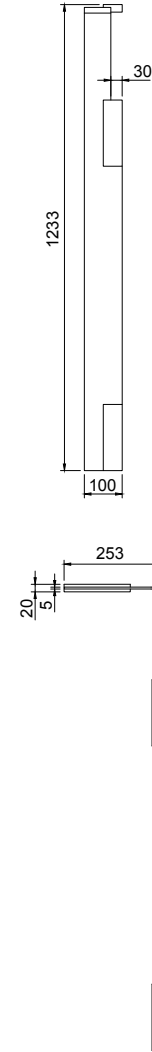
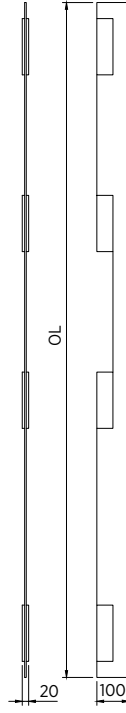
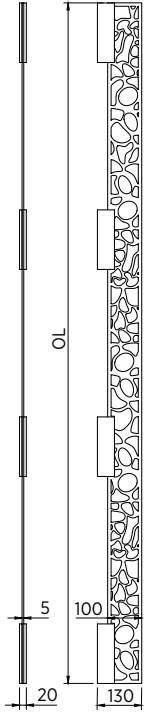

DB2009PL



DB2010PL



DB2013PL



DB2014PL

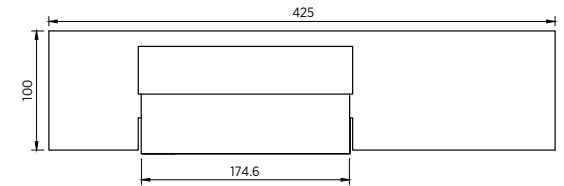
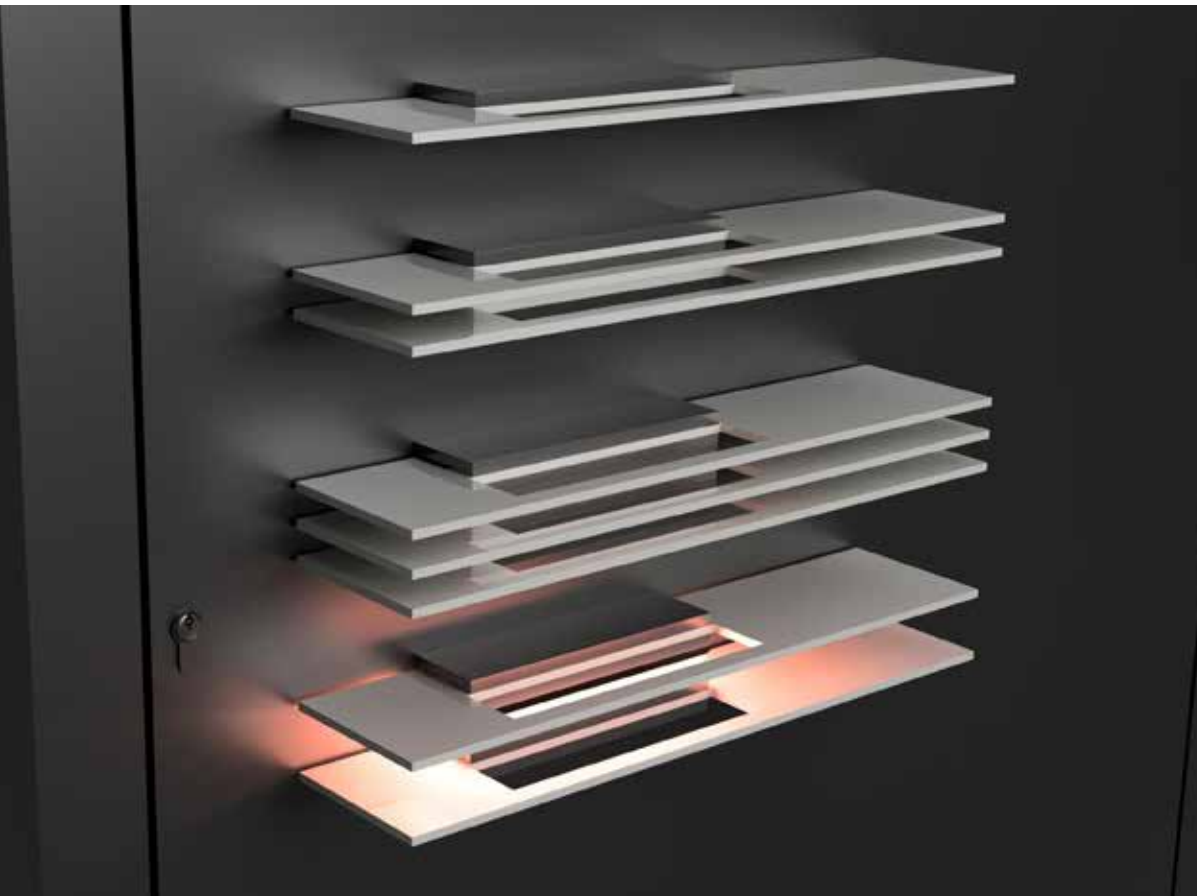

DB2011PL



DB2015PL

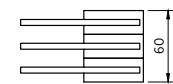

DB2012PL



DB2016PL



Montaje en puertas tradicionales

De serie las tuercas de fijación tienen siempre el mismo acabado que la manilla de la puerta solicitada



Instrucciones de montaje sobre un panel de hoja oculta Magnetude®

El montaje transversal en un panel Magnetude perjudica el funcionamiento del sistema antidilatación. Este método de fijación no está autorizado e invalida cualquier garantía relativa a una posible dilatación del panel.



Fijación invisible sobre un panel de hoja oculta Magnetude®

Los agujeros de fijación pueden ser proporcionados por nosotros en la chapa exterior si la posición se comunica al realizar el pedido, esto garantiza un montaje fluido y preciso.



Montaje ciego en panel tradicional

Esto sólo es posible si se instala en la hoja de la puerta y no en el panel.



Montaje en pareja sobre panel tradicional

Puede montarse en el marco de la puerta o en el propio panel.



Para saber qué artículos son aptos para montaje ciego o en pareja, consulte la página 2, donde encontrará esta información en el índice.



DB2009PL

MANTENIMIENTO Y GARANTIA

INOX :

La garantía de diez años se aplica a este tipo de artículos siempre y cuando las manillas y tiradores de acero inoxidable (aisi 316) sean limpiados regularmente con agua tibia y un paño suave. La superficie deberá secarse posteriormente con un paño para evitar la formación superficial de óxido y manchas por secado. Si es necesario, proteger con un limpiador especial para acero inoxidable o aplicar agentes de pulido para proporcionar una protección adicional, sólo si se siguen las instrucciones.

VZ :

Los tiradores de puertas de color negro envejecido se decoloran de forma natural con el uso. Por esta razón, no hay garantía sobre estos artículos. Recomendamos tratarlos regularmente con cera de abejas, además del mantenimiento habitual, para ralentizar este proceso.

VT-VB-SN :

Los tiradores de latón deben limpiarse regularmente con agua tibia y un paño suave. Con el tiempo adquirirán un color mate más cálido. Estos elementos no están cubiertos por la garantía.

RK :

Las manillas de cobre se oscurecen debido a la reacción química con el oxígeno, y se aclaran donde hay más fricción, por ejemplo, con el contacto humano, por lo tanto, no pueden garantizarse. Las manillas pueden protegerse mediante el uso regular de un barniz de cobre, siempre que siga las instrucciones.

ZW-PL :

Las manillas y tiradores de puertas con revestimiento termo lacado deben limpiarse periódicamente con agua tibia y un paño suave. Bajo esta condición, se benefician de una garantía de diez años. El uso de otros productos de limpieza específicos corre por su cuenta y riesgo. Aclarar siempre con abundante agua limpia y limpiar con un paño suave.

No utilice nunca estropajos de acero ni productos de limpieza muy abrasivos en los tiradores de las puertas. Utilice únicamente agua jabonosa no abrasiva o disolventes orgánicos o neutros para limpiar las manillas de las puertas.

NUESTRA GAMA COMPLETA

¿No encontró lo que estaba buscando?
Pregunte por nuestros otros folletos.

¿Apostamos que tenemos su puerta favorita?



frager.
CREATORS OF DOORS



frager.
magnetude® façade®
PATENTED TECHNOLOGY



Escanea para ver más modelos

Abelas Alexan SL

Parque Empresarial
A Laracha
Calle A1, Parcela B2
15145 A Laracha (A Coruña)
España

pedidos@frager.es
Tel. +34 981 61 28 87

www.frager.es